

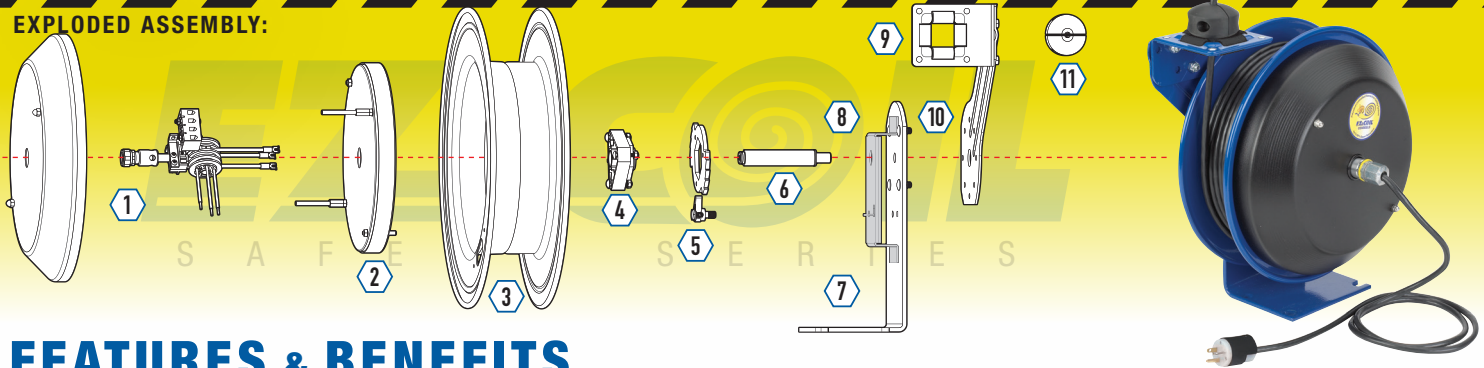

FEATURE FOCUS :: EZ-COIL® EQUIPPED

SPRING DRIVEN CORD REEL

EXPLODED ASSEMBLY:



FEATURES & BENEFITS

STEEL CONSTRUCTION

High-Quality steel construction provides superior strength and durability for heavy-duty applications in commercial and industrial settings.

EZ-COIL® EQUIPPED

A Coxreels patented safety system that retracts up to **80% SLOWER** than conventional reels

POWDER COAT

CPC™ Powder Coat. Long lasting, chip resistant and rust inhibiting CPC™ powder coat finish seals all steel components for maximum corrosion resistance.



1 COMPONENT COVER

External, easily accessible, heavy gauge CPC™ powder coated steel components cover for fast and simple slip ring routine maintenance. No need to remove the reel from its mount.

- Electrical current runs through a 25AMP / 600V rated slip ring (35AMP on selected models)
- Include 5' lead cable & grounding plug (Except on less cord models)

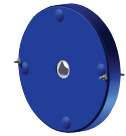

2 CARTRIDGE MOTOR

Lubricated and enclosed cartridge-style spring motor is easily removable for safe and convenient maintenance. Precision coil spring factory tuned and matched to application for longest life cycle and performance.



3 CNC SPUN DISCS

Heavy duty CNC robotically spun and ribbed discs with rolled edges for greater strength, durability, hose protection and operator safety.

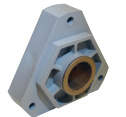

4 PRECISION BEARINGS

Sturdy permanently lubricated precision bearings for smooth rotation and trouble-free operation.



5 LOCKING RING

Multi-position, robust zinc plated locking ring and non-corrosive stainless steel lock ratchet mechanism to secure cord at desired length.



6 SOLID STEEL AXLE

1" solid steel axle with flat arbor for strong spring engagement and stainless steel set screw for non-corrosive port assembly provides solid internal core, long lasting use and reliable performance.

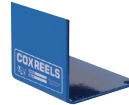

7 1/4" STEEL BASE

Sturdy single pedestal design with solid one piece, heavy gauge 1/4" steel base and support post, no weld, for maximum stability.



MOUNTING PATTERN

Simple slotted mounting pattern located in the steel base for fast and easy reel installation and detachment.



8 SUPER HUB™

Exclusive Super Hub™ dual axle support system increases the stability during operation, reduces vibration and strengthens the structural integrity of the reel.

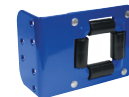
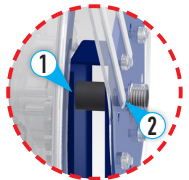

9 FOUR-WAY ROLLER BRACKETS

Pinch-proof four-way rollers allow the hose to be pulled from 360° for greater directional use coverage.

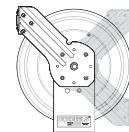

10 MULTI-POSITION GUIDE ARM

Versatile steel guide arm adjusts to wall, floor, ceiling & vehicle mounting positions.



11 CORD STOP

Adjustable solid rubber cord stop for convenient lead length positioning.

ACCESSORIES & UPGRADES



MOUNTING BRACKETS



POWER CORD & LIGHT OPTIONS



www.coxreels.com

800.COX.REEL

P: 480.820.6396

F: 480.820.5132

E: info@coxreels.com

FF-EZCR-01